

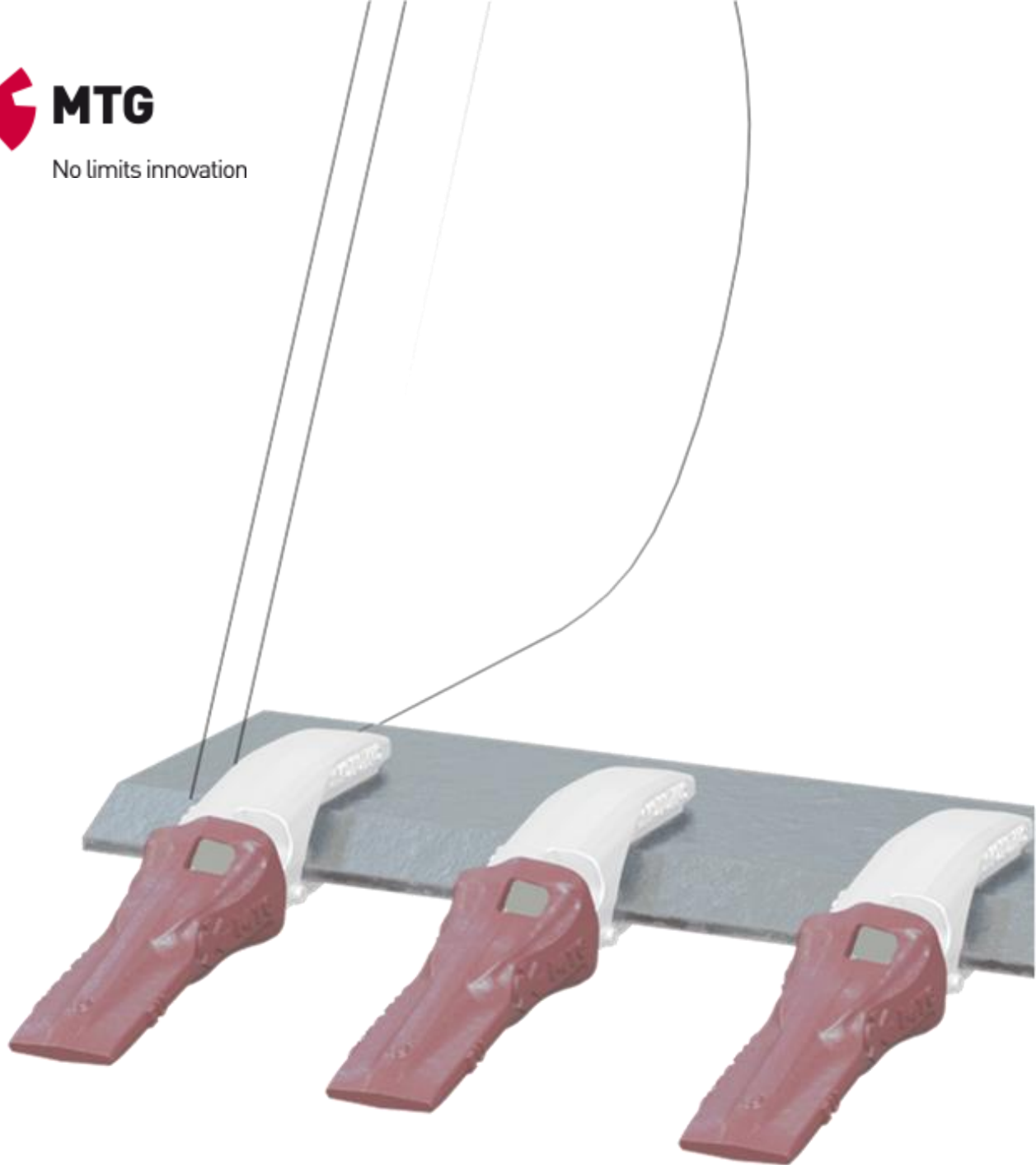

MTG

No limits innovation



INS.1.1.4

COMET Tooth System

Installation procedure

DISCLAIMER

© MTG, all rights reserved

The brands identified with an asterisk do not belong to METALOGENIA S.A. and this organization refers to them only to identify the destination of its products, without there being any relationship between METALOGENIA S.A. and the legitimate owners of any such brands.

Copy right: It is strictly forbidden for any person not belonging to MTG to distribute all or any part of the material set out in this document unless they are authorized to do so.

Liability: To ensure the correct use and handling of the MTG products without risk, please carefully read the corresponding service instructions set out on the MTG website. MTG will not be held liable for damages, loss, injury, or death arising from incorrect use or failure to heed the provisions of this guide. Similarly, MTG will not be held liable for damages caused due to the faulty installation or handling of its products. MTG likewise declines all liability for recommendations related to the use or handling of MTG products set out in documents not expressly authorized by MTG.

1. SAFETY

The practices described in this manual can be taken as guidelines for operating safely in many conditions and in addition to the safety standards that are current and enforceable in your area or region.

Your safety and the safety of third parties is the result of putting into practice your knowledge of the correct operational procedures.

Attention, when performing the work described in these instructions, always work safely and use the personal protection elements required to minimize or avoid injury. Always wear:



To avoid eye injury, always wear safety goggles or a protective mask when using any equipment, hammer or similar tool. When equipment is under pressure or when objects are struck, chips or other debris can be thrown out. Make sure no one gets hurt by the debris that is fired before applying pressure or hitting an object. Wear eye protection that complies with ANSI Z87.1 and OSHA standards. Also wear hearing protection and gloves.

Lifting a heavy object can cause serious or fatal injury. DO NOT exceed the maximum rated capacity of lifting and positioning devices: Stay away from the area under a suspended load.



LIFTING LUG

Make sure that the chain is not damaged and that the load is always balanced.

2. INSTALLATION PROCEDURE

2.1

Insert the tooth in the adapter.

NOTE: COMET is a symmetric system which allows to install the tooth in two different ways.

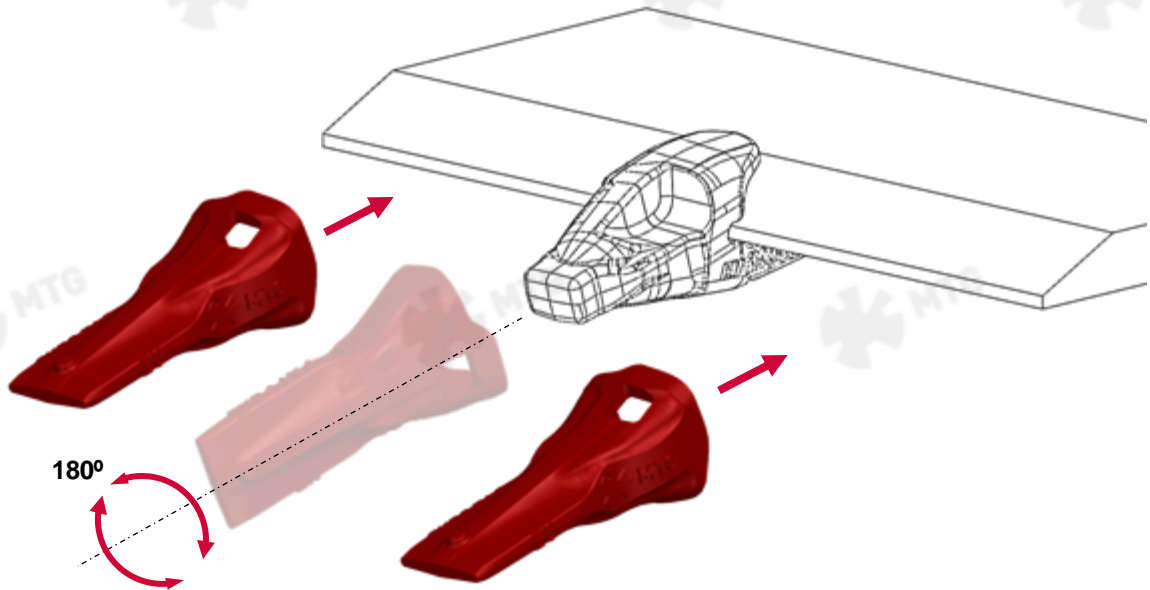

NOTE: Pay attention when installing CoMet teeth on loaders, certain designs, like the “L” are not designed to be rotated.

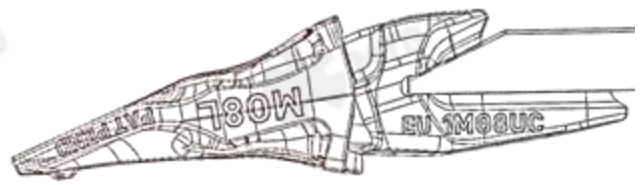

2.2 Introduce the pin with MTG's logo facing you. Push it in to compress the retention flap until it gets relaxed again.

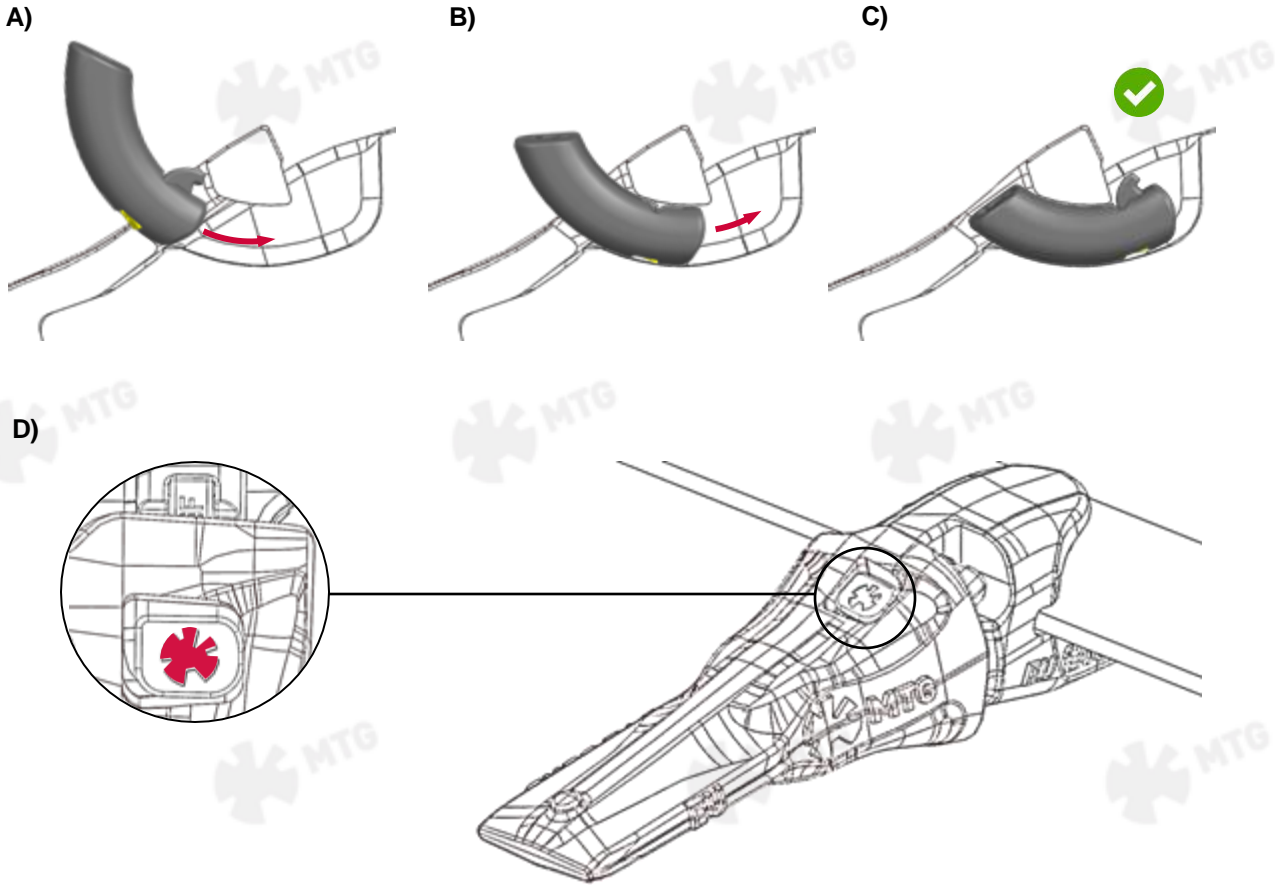

3. REMOVAL PROCEDURE

3.1 Place the pin body flush to the tooth if it is necessary.

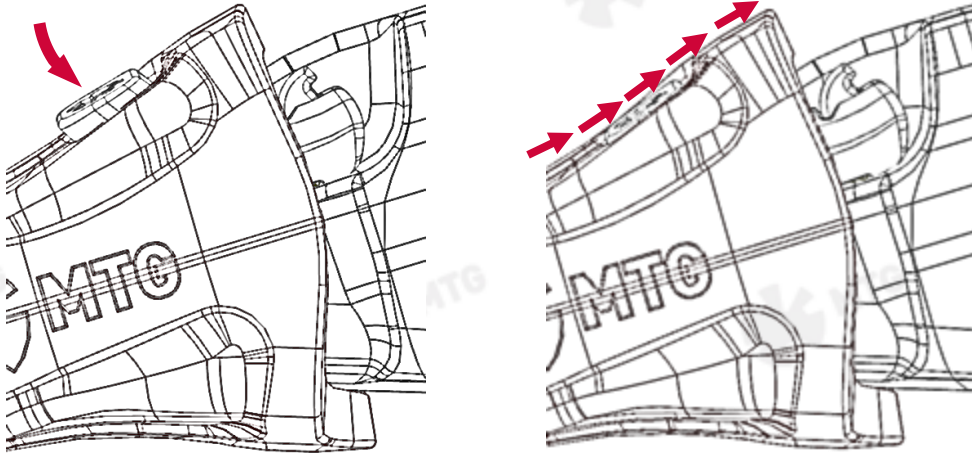

3.2 Press the retention flap by means of a screwdriver or similar on the flap groove [A] until it is fully compressed inside pin body [B]. Then, push the pin out until the retention flap is hidden inside the tooth [C]. Finally, push the pin out until the complete extraction [D].

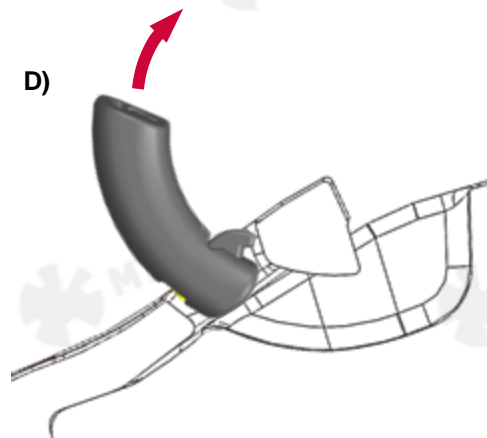
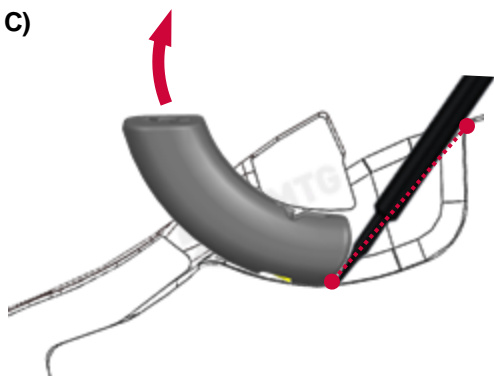
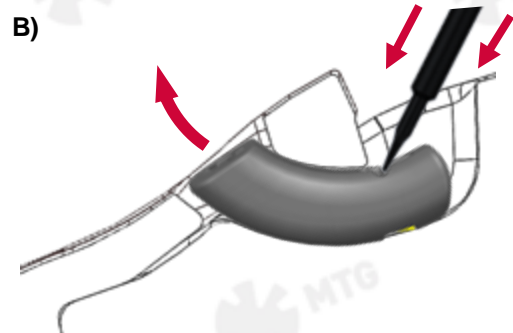
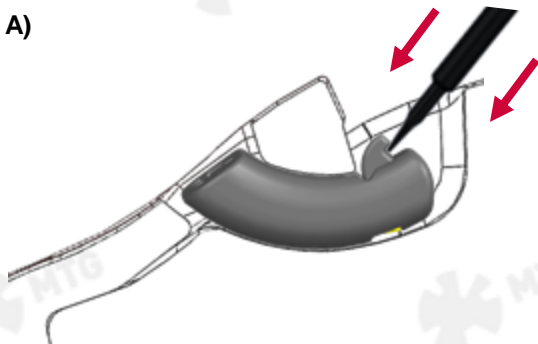



Service Instructions

The latest welding recommendations and assembly / disassembly instructions can be found online:

www.mtgcorp.com/manuals

Please contact Technical Services in case of questions:

technical.services@mtg.es



MTG HEADQUARTERS

Carrer d'Àvila, 45
08005 Barcelona (Spain)
(+34) 93 741 70 00
info@mtg.es

MTG NORTH AMERICA

4740 Consulate Plaza Drive
Houston, TX 77032 (USA)
+1 (281) 872 1500
info@mtgcorp.us

MTG AUSTRALIA

16 – 18 Thorpe Close
Welshpool, WA, 6106 (AUS)
+61 8 6248 6513
Info.australia@mtg.es