

BROCHURE

DREDGING SOLUTIONS

English Edition



MTG

No limits innovation

TABLE OF CONTENTS

About MTG	4
MTG Values	6
MTG Commitments	7
Specialists in wearparts	8
Our Strengths, Your Benefits	11
Dredging Solutions	12
Product Range	20
MTG CUTTERHEADS	20
MTG SYSTEMS / DMET	22
MTG PLUS / HELILOK* + SUPERCONICAL*	25
MTG CAST LIPS / TERRA	26
MTG SYSTEMS	28
TWINMET	28
STARMET	32
PROMET	34
KINGMET	38
MTG PLUS Shrouds	40
Testimonials	42

[*] Disclaimer

[1] The brands identified in this document do not belong to METALOGENIA S.A. and this organization refers to them only to identify the destination of its products, without there being any relationship between METALOGENIA S.A. and the legitimate owners of any such brands. The review and product performance information included in this document were provided by the client and in no way represent or imply warranty of any kind. The performance of MTG products will vary depending on many conditions that in no case can be neither controlled nor certified by METALOGENIA S.A. (machine type and use, installation and assembly procedures, materials and conditions of wear, product misuse).

[2] METALOGENIA S.A. is the sole holder of the brands that identify its products. Similarly, METALOGENIA, S.A. holds all the industrial property rights that may be derived from its products, such as designs, utility models or patents. The unauthorized use thereof may constitute a violation of METALOGENIA S.A.'s industrial property rights. The brands identified with an asterisk do not belong to METALOGENIA S.A. and this organization refers to them only to identify the destination of its products, without there being any relationship between METALOGENIA S.A. and the legitimate owners of any such brands.



MTG IN NUMBERS

With more than 65 years' experience, we are an independent and family-owned business specialized in the design and manufacture of high quality wearparts for earth-moving machinery. We operate in more than 60 countries all over the world.

65+

YEARS

experience in the design and manufacture of high quality wearparts for earth-moving machinery.

6

CSDs

out of the top 10 most powerful CSDs worldwide have been equipped with MTG CUTTERHEADS.

60+

COUNTRIES

are covered by our dealers, allowing us to be the global company we want to be, providing local service to our end users.

MTG IN THE WORLD

An international projection, with a regional commitment.



SOLUTIONS WE PROVIDE

MTG has gained a solid reputation in the Mining, Construction and Dredging industries by constantly challenging market standards and answering customer demands. Our deep knowledge in wear solutions has positioned us as a wearparts specialist, for our MTG branded products and for leading OEMs, providing custom-built solutions to satisfy their needs.

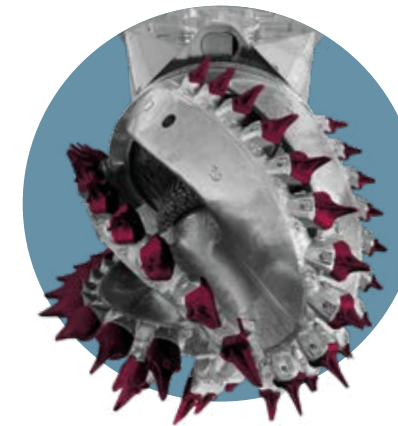

DREDGING SOLUTIONS

MTG provides solutions for dredging equipment. Find the best wear protection systems for your dredgers.

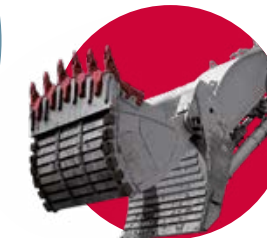

MINING SOLUTIONS

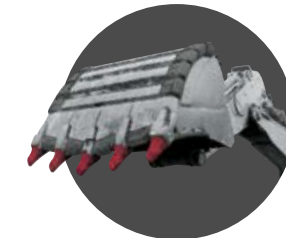

CONSTRUCTION SOLUTIONS



OEMS SOLUTIONS



CSD



BACKHOE DREDGER



TSHD



GRAB DREDGER

MTG VALUES

The results we obtain as well as the achievement of the objectives that we set for ourselves are not only the result of our experience and specialist knowledge but also because of how we make decisions and act, both collectively and individually. It is about our way of doing things, which is specified in five corporate values.

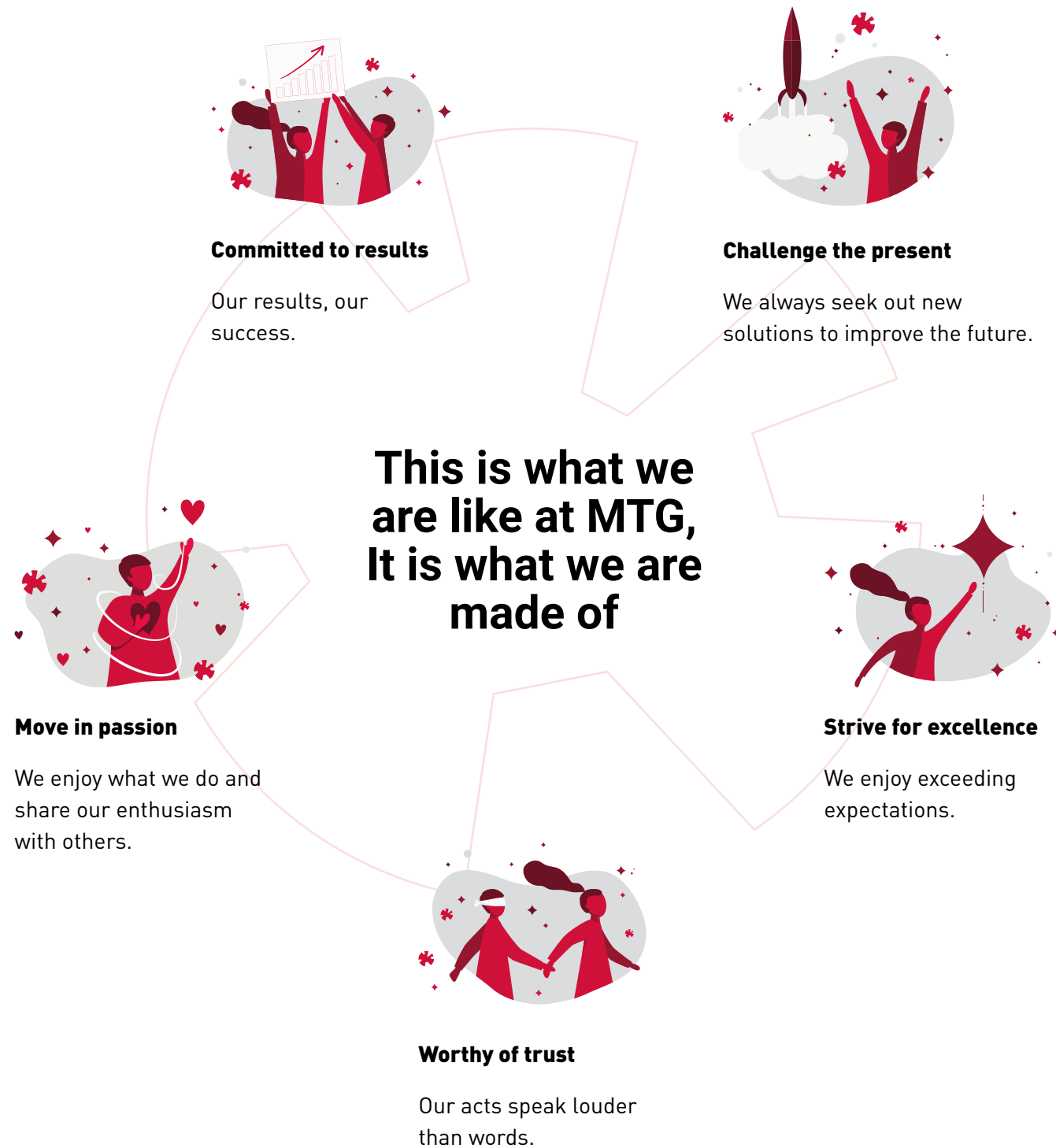

MTG COMMITMENTS

Quality, Health, Safety and Environment (QHSE) Policy

As a main tool for the achievement of corporate objectives, MTG has adopted the implementation of an Integrated Management System comprising the Quality Management System (ISO 9001), the Safety and Occupational Health System (ISO 45001), and the Environmental Management System (ISO 14001).



Sustainability Plan

In 2021 MTG has initiated the Paris Agreement adherence program on climate change, to accompany our customers and end users in minimizing their carbon footprint. MTG is now committed to developing and publishing a science-based action plan (*Science Based Targets Initiative*), aligned with the global objective of limiting global warming to well below 2 degrees Celsius compared to pre-industrial levels. Since its beginnings, MTG has always been committed to environmental protection and energy efficiency, as evidenced by holding an ISO 14001 certification since 1999, the annual results of energy audits and the efficiency indexes already achieved in comparison with the "Best Available Techniques Reference Document" of foundries in Europe.

With this project, MTG is taking a leap forward in its commitment to action and transparency, periodically communicating objectives and the progress made, in order to share our achievements with the different stakeholders.



Committed to the community

The investment of more than 10% of the budget in environment and safety reaffirms MTG's commitment to the environment and society. Its execution also has a very positive impact on economic development and the generation of employment in the region.



SPECIALISTS IN WEARPARTS

Each application and site conditions require specific solutions to ensure safety, reliability, durability and the utmost performance in operating efficiency. To that end, both Product Engineering and Product Manufacturing are a key factor.



Product Engineering

Our premium positioning is the result of decades of experience, innovation and investigations. All products created by MTG have been conceived and developed with a customer-centric mindset and through a very strict process leveraging our engineering expertise with state-of-the-art tools.

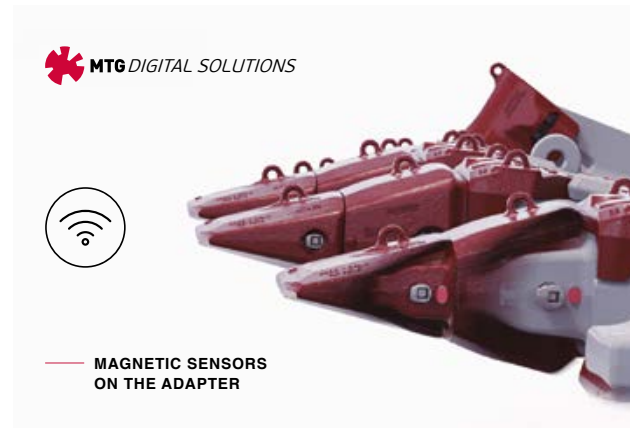

Digital Solutions

MTG's strong customer-centric vision and its technology and engineering expertise is evolving towards the development of a suite of digital solutions that will make operations safer and more efficient.



Product Manufacturing

Our own production plant, inaugurated in 2012, is one of the key pieces in MTG's commitment to quality and competitiveness in the wearparts market. The foundry, which is one of the most modern in Europe, is equipped with the most innovative technological facilities and various implementations of 4.0 industry.



Cutterheads Manufacturing

We provide our customers with top-quality cutterheads, built with the latest technology and the most accurate welding processes supported by our expertise in steels and in producing premium wearparts. Our dimensional requirements are very precise and guaranteed by our state-of-the-art procedures and our strict quality controls.

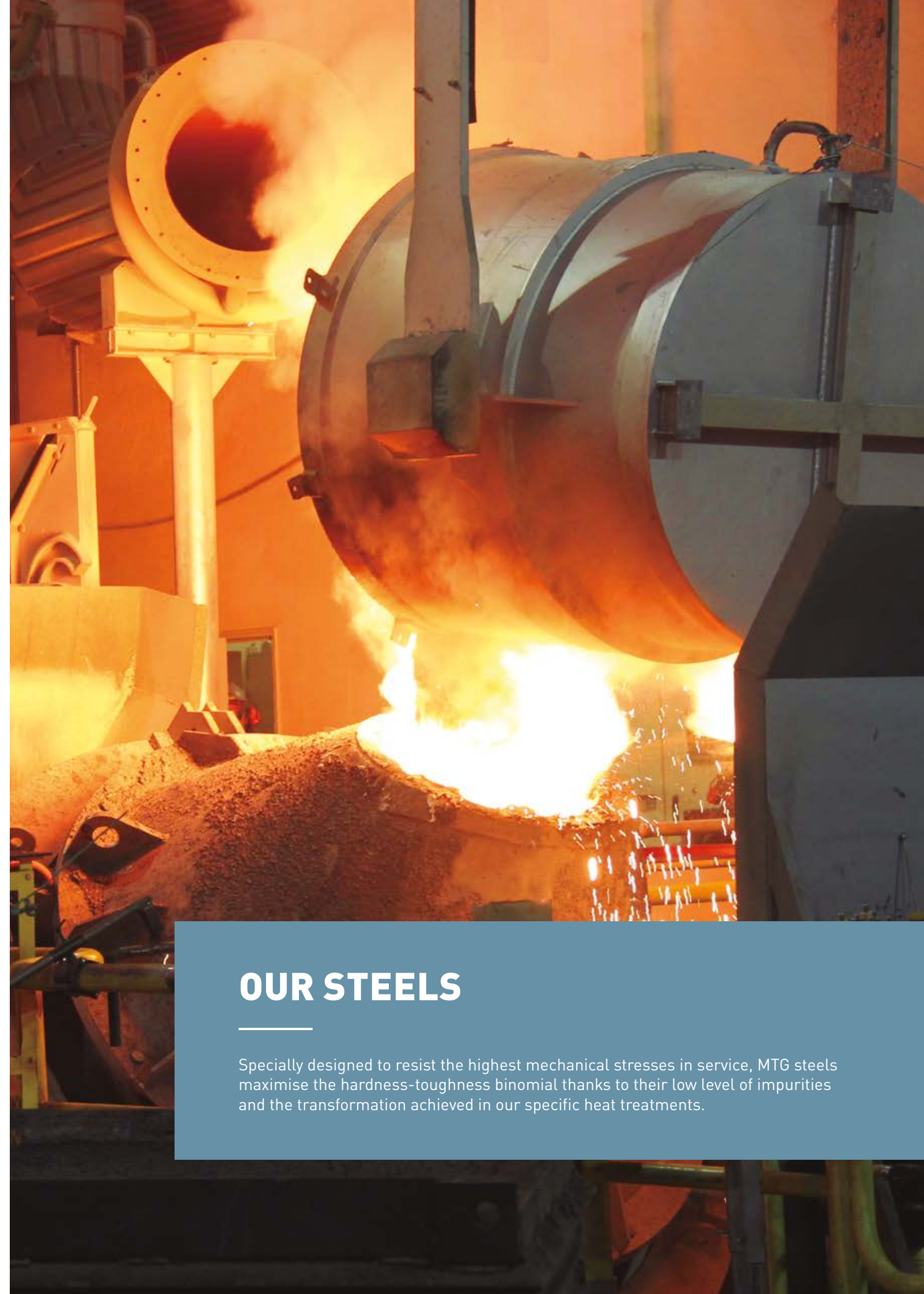

OUR STEELS

Specially designed to resist the highest mechanical stresses in service, MTG steels maximise the hardness-toughness binomial thanks to their low level of impurities and the transformation achieved in our specific heat treatments.

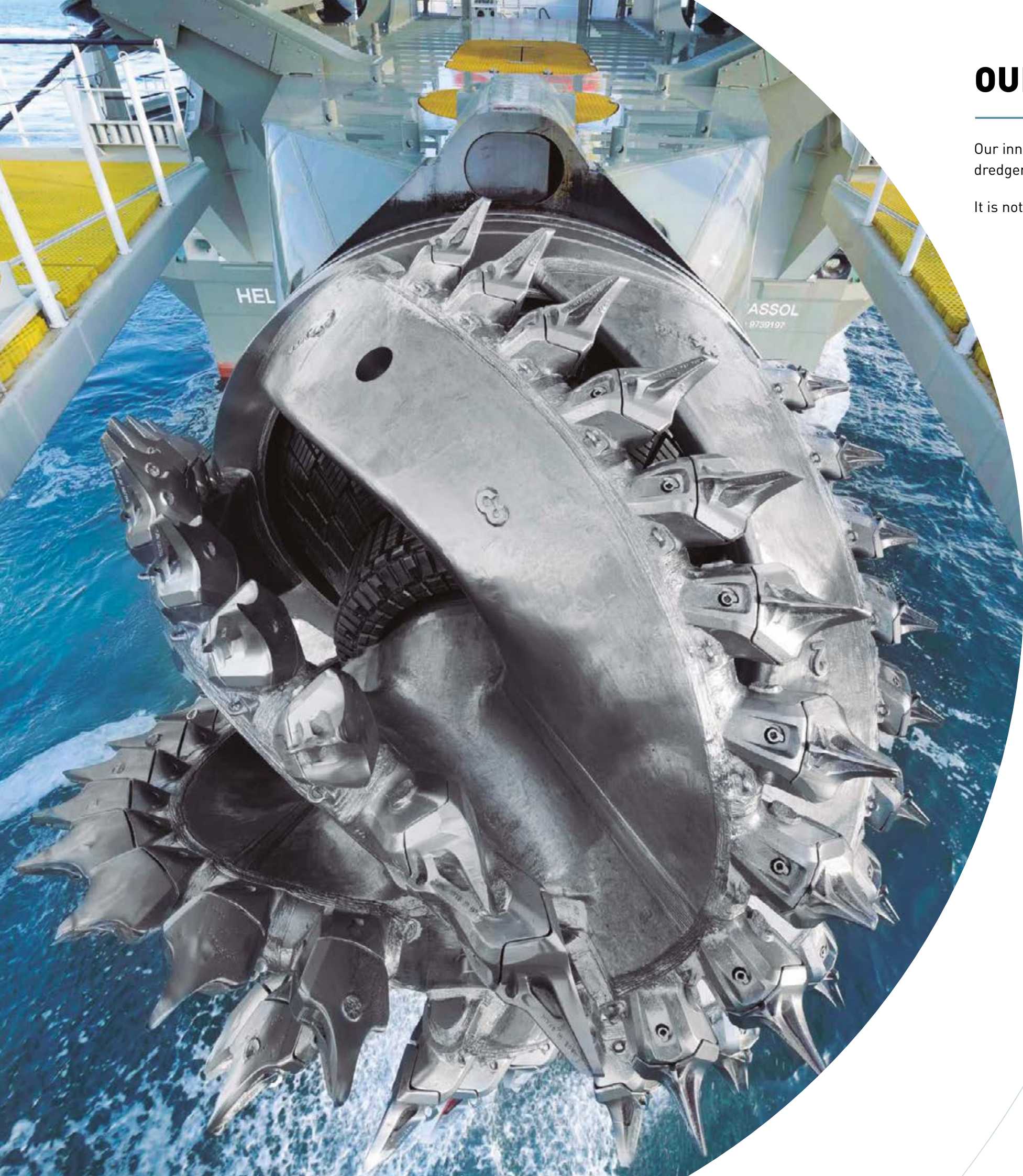

OUR STRENGTHS, YOUR BENEFITS!

Our innovative cutterheads and systems optimize the performance of our customers' dredgers.

It is not what we say, but what our customers say about us.



HIGHER PRODUCTIVITY

At MTG we provide a wide range of customer-tailored cutterheads as well as wearparts systems for dragheads and buckets aiming to increase the production of dredged material. Each wearpart is specifically designed for each application, depending on the level of penetration, abrasion and impact required.



65+ YEARS INNOVATING

MTG's permanent commitment to innovation, both in product design and production technology, has been and is our best future strategy. Thanks to our long-term partnerships and close collaborations with our customers, we have been able to develop customized and innovative solutions according to the market specific needs for more than 65 years.



HIGH QUALITY & RELIABILITY

Produced in Europe, our steels are designed to withstand the highest levels of mechanical stress and have proved robustness and resistance, even in the most demanding applications. Our high standards along with exhaustive quality controls make us a trusted partner for the most powerful mega-dredgers on the market.







WORLDWIDE TECHNICAL SERVICE

Our customers count on a flexible and experienced team, giving technical assistance and support all over the world. Our specialized technical engineers help you to find the most suitable dredging wearparts based on the ground and working conditions.

DREDGING SOLUTIONS

For all types of dredgers and applications.

PRODUCT CATEGORY	PRODUCT FAMILY	 CSD	 BACKHOE DREDGER	 TSHD	 GRAB DREDGER
MTG CUTTERHEADS Cutterheads solutions for Cutter Suction Dredgers.	MTG develops its own cutterheads, which are designed and tailored by our Engineering Team, using the most advanced CAD/CAM and prototyping technology, to meet our customers' specific needs. ↗ p.20	●			
MTG CAST LIPS Cast lip solutions for Grab Dredgers.	TERRA The most advanced and versatile cast lip option for standard to high performance applications. ↗ p.26		●		
MTG SYSTEMS Our most advanced tooth-adapter and shroud systems with intelligent lockings that provide a substantial added value to your dredging operations.	DMET Hammerless tooth-adapter system specially designed for Cutter Suction Dredgers (CSD). ↗ p.22	●			
	TWINMET The 3-part tooth system for backhoe and grab dredgers offers maximum durability even for the toughest dredging conditions. ↗ p.28		●		●
	STARMET Our proven hammerless tooth-adapter system specially designed to increase the productivity and to guarantee the maximum reliability for Backhoe Dredgers and Grab Dredgers. ↗ p.32		●		●
	PROMET Reliable bucket protection system for Backhoe Dredgers. ↗ p.34		●		
	KINGMET Robust and resistant teeth-adapter system that offers productivity and versatility for your TSHD. ↗ p.38			●	
MTG PLUS Complementary and direct replacement products made of our high-quality MTG steels.	DREDGE HELILOK* ↗ p.25	●			
	DREDGE SUPERCONICAL* ↗ p.25	●			
	Complementary Shrouds Weld-on Lip, Wing and Heel Shrouds. ↗ p.40		●		

CSD FULLY EQUIPPED CUTTERHEADS

DREDGERS
SUPPORTED

From Small to
Mega CSD
Cutter power up
to 7.500 kW

CSD TOOTH-ADAPTER SYSTEMS

DREDGERS
SUPPORTED

From Small to
Mega CSD
Cutter power up
to 7.500 kW

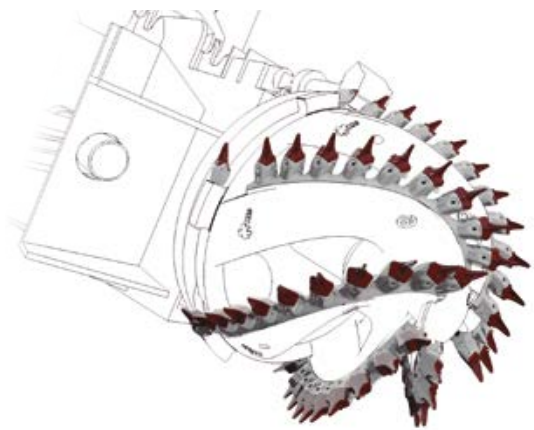

MTG CUTTERHEADS + DMET

The most advanced and customer-tailored cutterhead option for CSD high performance applications, along with our versatile hammerless tooth-adapter system.



DMET

Your best hammerless option to convert your existing cutterheads working in high performance applications, reducing downtimes and increasing safety.

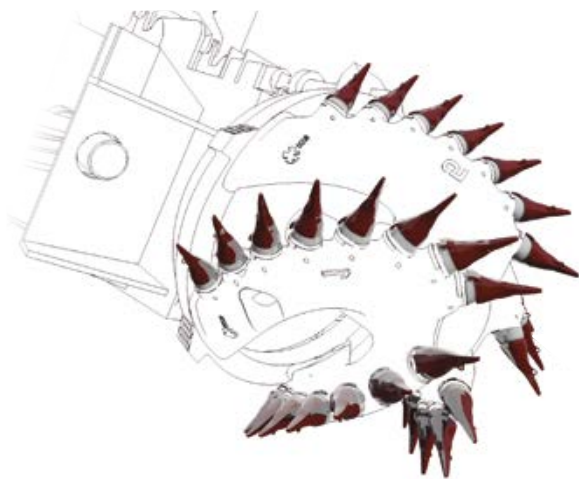

MTG CUTTERHEADS + PLUS

Try our robust and high quality alternative cutterhead option in combination with our reliable tooth-adapter system and the results will convince you to shift to more MTG products.



PLUS

Try our alternative reliable tooth-adapter system in your cutterheads and the results will convince you to shift to more MTG products.

MTG CUTTERHEADS
↗ p.20

MTG SYSTEMS
DMET ↗ p.22

MTG PLUS
↗ p.25

MTG SYSTEMS
DMET ↗ p.22

MTG PLUS
↗ p.25

BACKHOE DREDGER CAST LIPS

DREDGERS SUPPORTED

From Small to
Mega Backhoe Dredgers
Installed Power
up to 4,400 kW

BACKHOE DREDGER PLATE LIPS

DREDGERS SUPPORTED

From Small to
Mega Backhoe Dredgers
Installed Power
up to 4,400 kW



TERRA + TWINMET + PROMET + PLUS

The most advanced and versatile Cast Lip option, from standard to high performance applications, in combination with a robust tooth and easy to assemble shroud systems.



TWINMET Retrofit

Try our robust 3-part tooth system as a retrofit option and the results will convince you to shift to MTG cast lips.



STARMET + PROMET + PLUS

Your best hammerless option for high performance Backhoe Dredger applications with a versatile tooth system and easy to assemble shrouds.



STARMET + PROMET + PLUS

Your choice if you like to combine our versatile tooth system with flexible, weld-on lip shrouds.



TWINMET + PROMET + PLUS

For your bigger Backhoe Dredgers, we recommend our robust 3-part tooth system in combination with easy to assemble shrouds.



TSHD TOOTH-ADAPTER SYSTEMS

DREDGERS
SUPPORTED

From Small
to Mega TSHDs
All hopper capacities



GRAB DREDGER TOOTH-ADAPTER SYSTEMS

DREDGERS
SUPPORTED

From Small to Mega
Grab Dredgers
All bucket sizes
until 200 m³

KINGMET

Our versatile tooth system for dragheads allows you to choose from its wide range of designs according to the terrain.

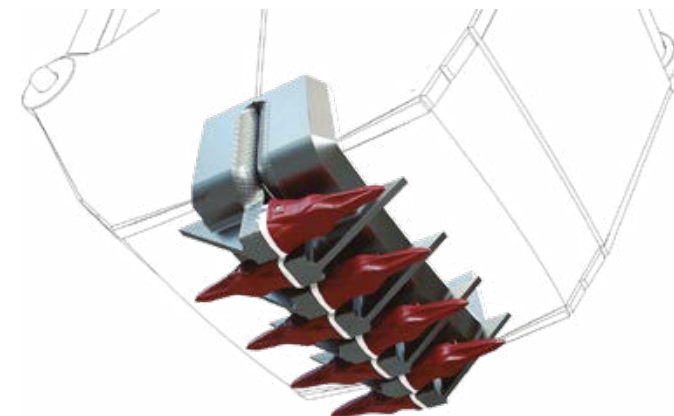
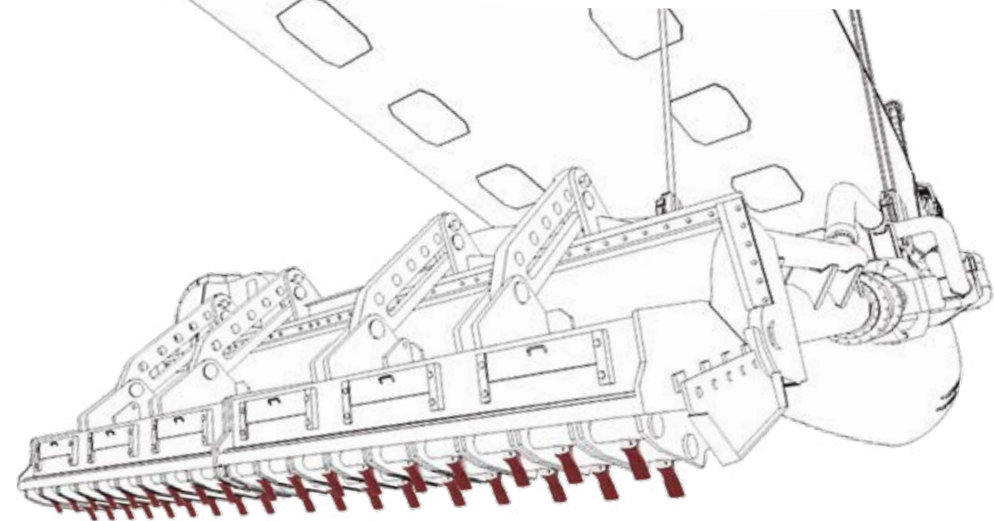

STARMET

Your best option for high performance applications with the penetrating teeth range of our hammerless system which reduces downtimes and increases safety of your Grab Dredger / Clamshell Dredger.



TWINMET

For your larger buckets, we recommend our robust and penetrating 3-part hammerless system which reduces downtimes and increases safety of your Grab Dredger / Clamshell Dredger.



CUTTERHEADS SOLUTIONS

HIGH PERFORMANCE

We pay special attention to **high-quality design and manufacturing** of our cutterheads as they largely define the performance of the dredger and we want our customers to have the optimal one.

TAILOR-MADE SOLUTIONS

We **customize each cutterhead** according to our customers' specific needs taking into account the application, the dredger specifications and the project requirements.

SPECIALIZED TEAM

At MTG we offer worldwide **technical services for cutterheads**, both on-site and in our facilities, which have the latest technology. Our customers can also benefit from dedicated **training from our engineers**.

PREMIUM STEELS

MTG Steels are specifically designed to **withstand the highest levels of mechanical stress** when operated. Our long tradition in the production of high quality steels along with the support of leading international experts allow us to meet the specific needs of our customers.

MTG CUTTERHEADS

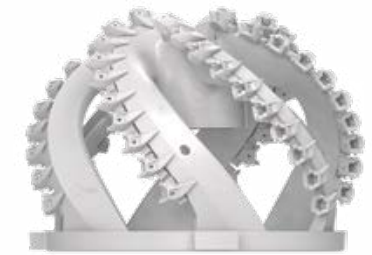

FOR ROCK TERRAINS

Equipped with **MTG SYSTEMS / DMET Tube adapters**

N° of Arms: from 5 to 8
Terrain: soft to very strong rock

FOR ROCK TERRAINS

Equipped with **MTG PLUS**

N° of Arms: from 5 to 6
Terrain: soft to very strong rock

FOR SAND & CLAY TERRAINS

Equipped with **MTG SYSTEMS / DMET Wing adapters**

N° of Arms: from 5 to 6
Terrain: sand and clay





DMET TOOTH-ADAPTER SYSTEM



The hammerless tooth-adapter system DMET has been specially designed to increase the productivity of your Cutter Suction Dredger.

The most powerful mega-dredgers on the market are already equipped with DMET.

Benefits and Features



GREATER DURABILITY

The **self-sharpening** tooth design combined with an increased wear material ratio offer the most efficient solution. The **tooth deflectors** protect the adapters from wear and extend their wear life, avoiding the need for adapters additional protection, like chocky bars or hard facing.



MAXIMUM RELIABILITY

The **stabilization** in all load directions guarantees the reliability of the entire system. The tooth-adapter contact surfaces are orientated according to the direction of the main forces, allowing **better load distribution**.



SAFE & QUICK MAINTENANCE

The **hammerless locking solution** makes tooth assembly and disassembly easier, safer and faster for the operators, reducing the machine's downtime. The **vertical position of the pin** facilitates the access to it and avoids pin loss during tooth replacement.



HIGHER PRODUCTIVITY

The **smooth system design** allows material to flow towards the inside of the cutterhead, increasing its suction efficiency and productivity. The **optimal functioning** of the system reduces the vibrations of the dredger while the increase of the tooth wear material and the durability of the adapters reduce the cost/m³.

Tooth Designs

A range of 4 tooth designs and 3 sizes are available within the DMET product family. We help you to choose the right combination of design and size to achieve the maximum productivity for your cutterhead and dredger.



CHISEL (C)



FLARED (F)



SHORT PICK POINT (P)



LONG PICK POINT (PX)

Adapter Designs

We have developed 3 designs available in 3 sizes for left or right rotation:



TUBE (TBL / TBR)

The Tube Design TBL (for left rotation) or TBR (for right rotation) designed for rock terrain.



WING (WIL / WIR)

The Wing Design WIL (for left rotation) or WIR (for right rotation) designed for sand & clay terrain.



WELD-ON (WNL / WNR)

The Weld-On Design WNL (for left rotation) or WNR (for right rotation) for backring.



MTG CUTTERHEADS
equipped with
MTG SYSTEMS
DMET ↗ p.20



MTG PLUS

Our high-quality wearparts manufactured in Europe are made of extremely wear resistant steel, which leads to a longer service life.

Direct Replacement Teeth for Your CSD

Try our alternative reliable teeth in your cutterheads and the results will convince you to shift to more MTG products.



DREDGE HELILOK*



DREDGE SUPERCONICAL*



TESTIMONIALS
↗ p.43



CAST LIP SOLUTIONS

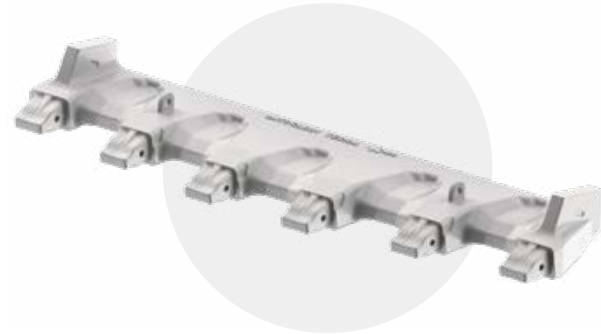

Cast Lip Sizes 148" - 201"

The most advanced cast lip option for Backhoe Dredgers to increase productivity in heavy dredging applications.

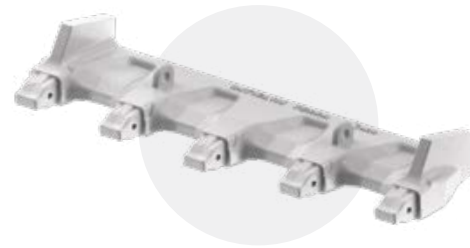

Cast Lip Sizes 116" & 136"

Smaller sizes of the field-proven TERRA series are an alternative to plate lip wearparts solutions.



Watch our 3D Video Animation!
CAST LIPS TERRA + TWINMET + PROMET

Benefits and Features



HIGHER PRODUCTIVITY

TERRA's **slim design** along with the self-sharpening design of its equipment, guarantee a steady penetration throughout their wear life.

REDUCED OPERATIONAL COSTS

The **optimized design** allows better distribution of the wear material. As a result, the **weight reduction** provides proven fuel and cost savings.

LONGER OPERATIONAL TIME

Large contact areas and **smooth transitions** for lip shrouds reduce plastic deformation at critical areas, preventing the generation of cracks.

SHORT DOWNTIMES

TERRA's critical areas are optimally protected by MTG's **specific wearparts** to increase the cast lip's wear life thus reducing rebuild needs.

Full Bucket Wear Packages

TERRA + TWINMET + PROMET

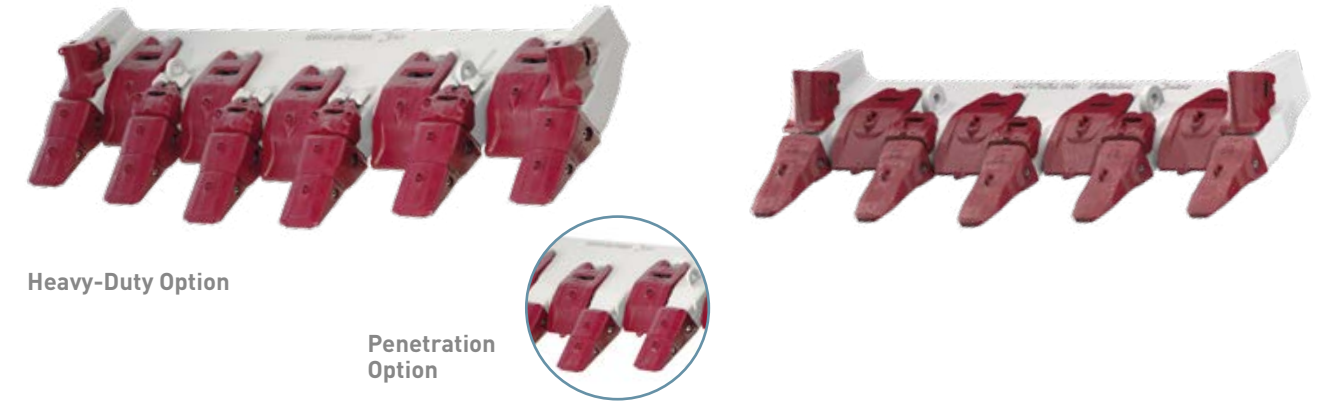

The combination of the robust TWINMET 3-part tooth system and PROMET lip shrouds offers an efficient and optimum wear protection. Depending on your requirements, the wearparts package can be optimized for penetration or heavy-duty applications.

The 2-part TWINMET tooth system and PROMET shrouds complement the smaller cast lip sizes to offer optimal bucket penetration. For more abrasive applications, an optional wear cap provides additional protection.

TERRA Range Overview

CAST LIP TERRA	REFERENCE	TWINMET SIZE	NUMBER OF POSITIONS
116" / 2.950 mm	1MT1CL116 TERRA	TM1	5
136" / 3.450 mm	1MT1CL136 TERRA	TM1	5
148" / 3.760 mm	1MT5CL148 TERRA	TM5/4 TM5/6	5
163" / 4.150 mm	1MT5CL163 TERRA	TM5/4 TM5/6	5
169" / 4.300 mm	1MT5CL169 TERRA	TM5/4 TM5/6	6
169" / 4.300 mm	1MT7CL169 TERRA	TM7/4 TM7/6	5
201" / 5.100 mm	1MT7CL201 TERRA	TM7/4 TM7/6	6



TWINMET FOR CAST LIPS



TWINMET 1, 5 & 7

Either as a 2 part or 3 part tooth system, TWINMET stands for high performance and is the optimal solution for toughest dredging applications in combination with a cast lip. A wide range with different size options provides solutions for Backhoe and Grab Dredgers.

TWINMET Retrofit

Try our robust tooth system as retrofit option for cast lip buckets.

Benefits and Features



MAXIMUM RELIABILITY

A reinforced nose and fitting design as well as large stabilization surfaces provide maximum **robustness and resistance** to heaviest loads and impacts.

REDUCED OPERATIONAL COSTS

The **symmetrical design** allows to reverse intermediate adapters and teeth. Flipping them extends their wear life.

SHORT AND SAFE DOWNTIMES

A **hammerless dual pin locking system** joins all three parts to one high performance tooth system and allows a quick and safe maintenance in any working conditions.

HIGHER PRODUCTIVITY

The **self-sharpening designs** allow our wearparts a high degree of penetration during all their wear life, keeping your dredger's high performance and reducing the operating costs.

Find Your Tooth Design

SIZE	TWINMET 1			TWINMET 5 & 7				
TOOTH DESIGN								
	EXTRA (E)	EXTRA X (EX)	VECTOR (V)	EXTRA X (EX)	IMPACT (I)	PENETRATION (P)	UNIVERSAL (U)	DOUBLE VECTOR (W)
PENETRATION	●●○	●●○	●●●	●●○	●●●	●●●	●●○	●●●
ABRASION	●●●	●●●	●○○	●●●	●●○	●●○	●●○	●○○
IMPACT	●○○○	●●○○	●○○○	●●○○	●●●●	●●○○	●●○○	●●○○

Choose Your Intermediate Adapter

MTG offers two variants of intermediate adapters: Standard (STD) and Heavy-Duty (HD). While the Standard version is more suitable for terrains that require high penetration, the heavy-duty option provides more resistance in terrains with high level of abrasion and impacts.



STD

HD

TWINMET Range for CAST LIPS / TERRA

TWINMET SIZES	TEETH	TOOTH LOCKING		INTERMEDIATE ADAPTER	INTERMEDIATE LOCKING		WELD-ON NOSE	REMOVAL TOOL
		PIN	RETAINER ⁴		PIN	RETAINER ⁴		
TM1	TM1 MT1E MT1EX MT1V	2MT1P	2MJ1 STR	-	-	-	1MT1WN	3MT3/4-1
TM 5/4	TM4 MT4EX MT4I MT4P MT4U MT4W	2MT4P 2MT4PSE	2MJ4 STR	5MT54 5MT54X 5MT56 ¹	-	-	-	3MJ
	TM5	MT5U ³	-		-	2MT5P 2MT5PSE	2MJ5 STR	
TM 7/6	TM6 MT6EX MT6P MT6U MT6W	2MT4P 2MT4PSE	2MJ4 STR	5MT74 ² 5MT76 5MT76X	-	-	-	3MJ
	TM7	-	-		-	2MT5P 2MT5PSE	2MJ5 STR	

¹ TWINMET 5/6 consists of an intermediate adapter that combines tooth size 6 with nose size 5.
² TWINMET 7/4 consists of an intermediate adapter that combines tooth size 4 with nose size 7.
³ MT5U is a solid tooth that does not require an intermediate adapter.
⁴ Retainer included in tooth and intermediate adapter but can also be ordered separately.

TESTIMONIALS
[↗ p.47](#)



TWINMET FOR PLATE LIPS



TWINMET 1

The 2-part tooth-adaptor system is especially designed for smaller Backhoe and Grab Dredgers with a plate lip thickness of 140 mm.

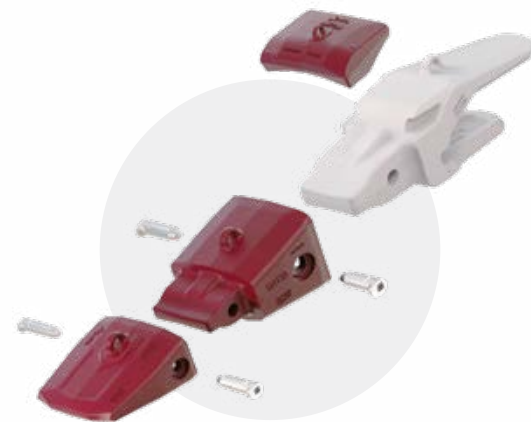

TWINMET 3/2

The 3-part tooth-adaptor system offers robustness and long wear life for Backhoe and Grab Dredgers with a plate lip thickness of 140 or 160 mm.

Benefits and Features



MAXIMUM RELIABILITY

A reinforced nose and fitting design as well as large stabilization surfaces provide maximum **robustness and resistance** to heaviest loads and impacts.



REDUCED OPERATIONAL COSTS

The **symmetrical design** allows to reverse intermediate adapters and teeth. Flipping them extends their wear life.



SHORT AND SAFE DOWNTIMES

A **hammerless dual pin locking system** joins all three parts to one high performance tooth system and allows a quick and safe maintenance in any working conditions.



HIGHER PRODUCTIVITY

The **self-sharpening designs** allow our wearparts a high degree of penetration during all their wear life, keeping your dredger's high performance and reducing the operating costs.

Find Your Tooth Design

SIZE	TWINMET 1				TWINMET 3/2			
TOOTH DESIGN								
	EXTRA (E)	EXTRA X (EX)	VECTOR (V)	EXTRA X (EX)	IMPACT (I)	PENETRATION (P)	UNIVERSAL (U)	DOUBLE VECTOR (W)
PENETRATION	●●○	●●○	●●●	●●○	●●●	●●●	●●○	●●●
ABRASION	●●●	●●●	●○○	●●●	●●○	●●○	●●○	●○○
IMPACT	●○○○	●●○○	●○○○	●●○○	●●●●	●●○○	●●○○	●●○○

Choose Your Adapter Option

With the central (WC) and corner weld-on adapters (WL / WR) of size 1 and 3/2, TWINMET also becomes a solution for Backhoe and Grab Dredgers with plate lip. It is the perfect option for those who prefer a plate lip solution.



CENTRAL ADAPTER (WC)



CORNER ADAPTER (WL / WR)

TWINMET Range for Plate Lips

TWINMET SIZES	TEETH	TOOTH LOCKING		INTERMEDIATE ADAPTER	INTERMEDIATE LOCKING		PLATE LIP ADAPTERS	WELD-ON NOSE	REMOVAL TOOL	
		PIN	RETAINER ¹		PIN	RETAINER ¹				
TM1	TM1	MT1E MT1EX MT1V	2MT1P	2MJ1 STR	-	-	-	1MT1WC140 1MT1WL140 1MT1WR140	1MT1WN	3MT3/4-1
	TM2	MT2EX MT2U MT2W	2MT2P	2MJ2 STR	-	-	-	-	-	3MT3/4-1
TM 3/2	TM3	-	-	-	5MT32	2MT3P	2MJ3 STR	1MT3WC140 1MT3WC160 1MT3WL160 1MT3WR160	1MT3WN	-

¹ Retainer included in tooth and intermediate adapter but can also be ordered separately.



STARMET TOOTH-ADAPTER SYSTEM



Our proven hammerless tooth-adapter system specially designed to increase the productivity and to guarantee the maximum reliability for Backhoe and Grab Dredgers.

Benefits and Features



SHORT AND SAFE DOWNTIMES

Changeout of our teeth is fast and safe thanks to our **hammerless locking**. It is intuitive and easy to use and offers excellent retention thus preventing tooth loss.



HIGHER PRODUCTIVITY

Our **self-sharpening designs** offer a high level of penetration throughout their wear life, improving your dredger's performance.



LONGER OPERATIONAL TIME

Due to the **optimal wear material ratio** and wear distribution, our wearparts last longer, reducing your operating costs.



OPTIMAL PERFORMANCE

Thanks to our **wide product range**, we are able to offer you a specific tooth design depending on the level of penetration, abrasion and impact required.

Find Your Tooth Design

STARMET										
TOOTH DESIGN	COAL (C)	CHISEL EXTRA (CX)	EXTRA (E1)	EXTRA X (EX)	EXTRA XX (EXX)	IMPACT (I)	PENETRATION (P)	UNIVERSAL (U)	VECTOR (V)	DOUBLE VECTOR (W)
PENETRATION	●●●	●○○	●●○	●●○	●○○	●○○	●●○	●○○	●●○	●●○
ABRASION	○○○	●●○	●●○	●●○	●●○	●○○	●○○	●○○	●○○	●○○
IMPACT	○○○○	●○○○	●○○○	●○○○	●○○○	●●●●	●●●○	●○○○	●○○○	●○○○

Choose Your Adapter Option

Find the adapter option that best suits your needs depending on your application.



CENTRAL ADAPTER (WC / WLD / WRD)



STRADDLE ADAPTER (WS)



CORNER ADAPTER (WL / WR)



WELD-ON NOSE (WN)



FLUSH ADAPTER (FC)

Wear Caps for Additional Protection

The adapters can optionally be equipped with a mechanical wear cap. Two different wear cap designs are available to protect efficiently depending on the terrain's abrasion level and type of application.



TESTIMONIALS
→ p.46



PROMET LIP SHROUDS

Lip protection solutions for different dredging applications with a reliable hammerless locking.

Benefits and Features



MAXIMUM RELIABILITY

Our premium steels made in Europe have proved **robustness and resistance**, even in the most demanding applications.



LONGER OPERATIONAL TIME

Due to the **optimal wear material ratio and wear distribution** of our protectors' designs, they last longer, reducing the operating costs.



SHORT AND SAFE DOWNTIMES

Our innovative and easy-to-use **hammerless lockings** enhance the safety and efficiency of your operations, with shorter downtimes.



INCREASED PRODUCTIVITY

The range of **self-sharpening** lip and wing shrouds boosts the bucket efficiency while the **optimal protection** increases its capacity volume.

Lip Shrouds for Cast Lips

Especially designed for the TERRA range, the PROMET lip shrouds optimally protect the cast lip to increase wear life thus reducing rebuild needs. Different lip shroud designs are available that either contribute to a better penetration or are especially designed for heavy-duty applications that provide more resistance against impacts and abrasion.



Lip Shrouds for Plate Lips

PROMET shrouds for plate lips are available in central or left / right delta designs.





PROMET WING SHROUDS

Wing protection solutions for different dredging applications with a reliable hammerless locking.

Benefits and Features



MAXIMUM RELIABILITY

Our premium steels made in Europe have proved **robustness and resistance**, even in the most demanding applications.



LONGER OPERATIONAL TIME

Due to the **optimal wear material ratio and wear distribution** of our protectors' designs, they last longer, reducing the operating costs.



SHORT AND SAFE DOWNTIMES

Our innovative and easy-to use **hammerless lockings** enhance the safety and efficiency of your operations, with shorter downtimes.



INCREASED PRODUCTIVITY

The range of **self-sharpening** lip and wing shrouds boosts the bucket efficiency while the **optimal protection** increases its capacity volume.

U Wing Shroud (≤60 mm)

Reversible wing shroud design with 70% wear material ratio for standard application and for side wall thicknesses up to 60mm. The PROMET II locking based on pin and retainer provides maximum reliability and offers quick and safe change-outs.



UX Wing Shroud (60-140 mm)

The extremely robust design with 70% wear material ratio is ideal for heavy-duty applications and especially resistant in very abrasive soils. The PROMET II locking based on pin and retainer provides maximum reliability and offers quick and safe change-outs.



UX-S Wing Shroud (80-140 mm)

The UX-S wing shrouds are especially designed for bigger buckets with a sidewall thickness of 80 to 140 mm. The robust and symmetrical design provides maximum resistance in heavy-duty applications and can be exchanged between both sides for longer wear life.

The innovative PROMET III locking system does not require sidewall holes. The weld-on base + locking in combination with weld-on stoppers provide maximum reliability while also allowing quick change-outs.





KINGMET TOOTH-ADAPTER SYSTEM



Our field-proven and robust KINGMET features a conventional vertical locking system that is easy to insert and remove. This versatile tooth system for dragheads allows you to choose among its wide range of designs according to the terrain.

Find Your Tooth Design

Each application and site conditions require a specific tooth profile to ensure the best performance throughout the whole wear life of the tooth. Our wide range of tooth designs offers suitable options according to the existing level of penetration, abrasion and impact. Our self-sharpening tooth profiles have an optimal wear material distribution that makes them last longer.

KINGMET									
TOOTH DESIGN	EXTRA (E)	FLARED (F)	HEAVY (H)	IMPACT (I)	LONG (L)	STANDARD (S)	UNIVERSAL (U)	VECTOR (V)	DOUBLE VECTOR (W)
PENETRATION	●●●	●●○	●○○	●○○	●●○	●●○	●●○	●●●	●●●
ABRASION	●●●	●●○	●●●	●○○	●●○	●●○	●●○	●○○	●○○
IMPACT	●●○○	●●○○	●○○○	●●●●	●●○○	●●○○	●●○○	●○○○	●○○○

Choose Your Adapter Option

Find the adapter option that best suits your needs depending on your application.



FLUSH ADAPTER (FC)



WELD-ON ADAPTER (WS)



WELD-ON NOSE (WN)

Benefits and Features



MAXIMUM RELIABILITY

Our premium steels made in Europe have proved **robustness and resistance**, even in the most demanding applications.



INCREASED PRODUCTIVITY

Our **self-sharpening** designs offer a high level of penetration throughout their wear life, improving your dredger's performance.



LONGER OPERATIONAL TIME

Due to the **optimal wear ratio** and wear distribution of our tooth designs, they last longer, reducing your operating costs.



OPTIMAL PERFORMANCE

Thanks to our **wide product range**, we are able to offer you a specific tooth design depending on the level of penetration, abrasion and impact required.

TESTIMONIALS
↗ p.45



COMPLEMENTARY SHROUDS

We offer lip, wing and heel shrouds for Backhoes.



WELD-ON LIP SHROUDS

Suitable for plate lip with versions for central or delta left / right lip positions.



WELD-ON WING SHROUDS

Lateral weld-on protectors as standard or heavy-duty option for plate lip.



WELD-ON HEEL SHROUDS

Complementary bucket protection for Backhoe Dredgers.



Bucket equipped with

MTG SYSTEMS

STARMET ↗ p.32 PROMET ↗ p.34



Customer:
Royal Boskalis Westminster N.V.

Country:
United Arab Emirates

Terrain:
Rock

Abrasion level:
Medium

Impact level:
Medium

Dredger

Type: **CSD**
Model: **Cutter Dredger Taurus**

Cutterhead Configuration

DMET: **1MD7ATBR**
MD7AP4

Results

1. High reliability and maximum productivity.
2. Fewer stops for maintenance.
3. Optimum cutterhead penetration.



Customer:
Jan De Nul Group

Country:
Panama

Terrain:
Rock

Abrasion level:
High

Impact level:
Medium

Dredger

Type: **CSD**
Model: **Cutter Suction Dredger Niccolo
Machiavelli 7000 Kw power**

Cutterhead Configuration

MTG PLUS HELILOK®: **1MSV68SR**
MSV68P

Results

- Exceptional results and quality wearparts.
1. Resistant wearparts with good penetration.
 2. Excellent performance of the cutterhead.





Customer:
Royal Boskalis Westminster N.V.

Country:
Qatar

Terrain:
Limestone

Abrasion level:
Very high

Impact level:
Very high

Dredger

Type: **CSD**
Model: **Cutter Dredgers Taurus & Phoenix**

Cutterhead Configuration

DMET: **1MD7ATBR**
MD7AP4

Results

"MTG's products offer maximum reliability and increased the productivity."



Customer:
Holland Marine Technologies BV

Country:
The Netherlands

Terrain:
Ocean Floor

Abrasion level:
Medium - High

Impact level:
High

Dredger

Type: **TSHD**
Model: **TSHD 5250 m³**

Draghead Configuration

KINGMET: **1MG20FC/MG20U**

Results

"We've perfectly solved our issue of variation in dredged-soil conditions with MTG SYSTEMS / KINGMET. KINGMET tooth's change is easy and it provides a durable and highly wear-resistant cutting solution. We really appreciate both efficient dredging operations and the quick response given by MTG service team." HollandMT Engineering Manager.





Customer:
DEME Group

Country:
Singapore

Terrain:
Clay

Abrasion level:
Low

Impact level:
Medium

Dredger

Type: **Grab Dredger**
Model: -

Clamshell Configuration

STARMET: **1MA500WN
MA500P**

Results

“Since using MTG SYSTEMS / STARMET teeth-adapter system the cutting process has been optimised, increasing savings and productivity.”



Customer:
DEME Group

Country:
Singapore

Terrain:
Hard rock

Abrasion level:
High

Impact level:
High

Dredger

Type: **Grab Dredger**
Model: **Clamshell Goshu with heavy duty bucket (136 m³)**

Clamshell Configuration

TWINMET: **1MT5WN
5MJ54
MT4U**

Results

“MTG has given an excellent service, from the study and proposal to the on-site monitoring during the installation and start-up of the grab works using TWINMET. With MTG SYSTEMS / TWINMET, we can work in the toughest areas, increasing the productivity and ensuring compliance with the deadlines of our project”. Technical Department, DIAP (Deme International Asia Pacific).





mtgcorp.com



Download
Brochure



Follow Us
on LinkedIn

MTG HEADQUARTERS

📍 Carrer d'Àvila, 45
08005 Barcelona (Spain)
☎ (+34) 93 741 70 00
✉ info@mtg.es

MTG NORTH AMERICA

📍 15700 International Plaza Drive
Houston, TX 77032 (USA)
☎ +1 (281) 872 1500
✉ info@mtgcorp.us

MTG AUSTRALIA

📍 85 Sheffield Road
Welshpool, WA, 6106 (AUS)
☎ +61 8 6248 6513
✉ info.australia@mtg.es

MTG Quality Certificates

